

Baptistry Models

Single Entry Models

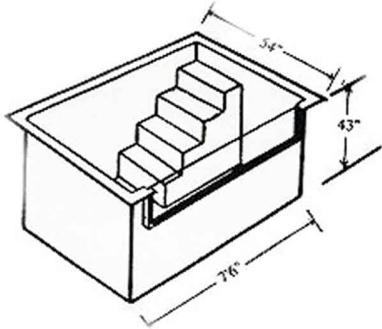

Model 7A - Price \$1369.00
7' 6" L x 4' 6" W x 43" D - 675 gals. - 310 lbs.
Window add \$225.00

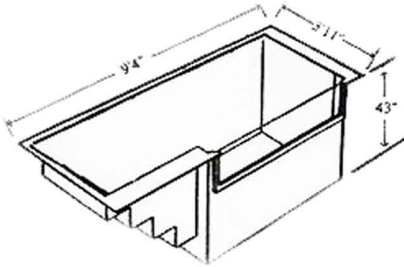

Model 11B - Price \$1159.00
9'4"L x 47"W x 43"D - 575 gal. - 275 lbs.
Window add \$200.00

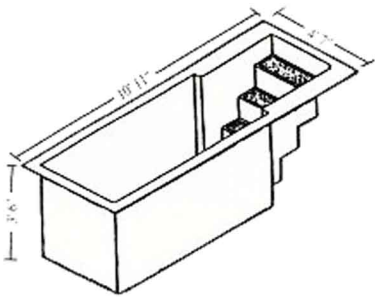

Model 12B - Price \$1399.00
10'11"L x 55"W x 43"D - 675 gal. - 310 lbs.
Window add \$225.00

Double Entry Models

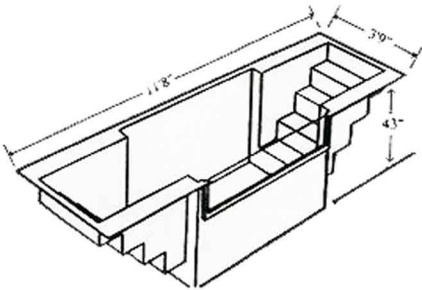

Model 9A - Price \$1369.00
11'8"L x 45"W x 43" D - 450 gal. - 290 lbs.
Window add \$200.00

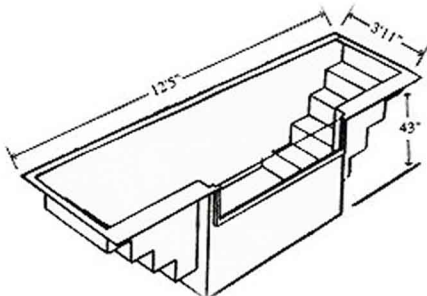

Model 11A - Price \$1399.00
12'5"L x 47"W x 43"D - 550 gals. - 280 lbs.
Window add \$225.00

Baptistry Models

Extra Wide Models

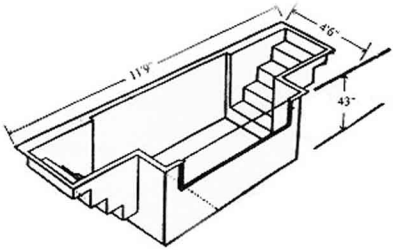

Model 10A - Price \$1369.00
 11'9"L x 54"W x 43"D - 600 gals. - 270 lbs.
 Window add \$200.00

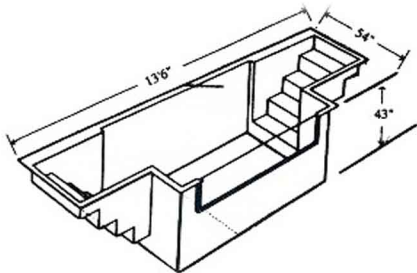

Model 13A - Price \$1499.00
 13'6"L x 54"W x 43"D - 750 gals. - 320 lbs.
 Window add \$225.00

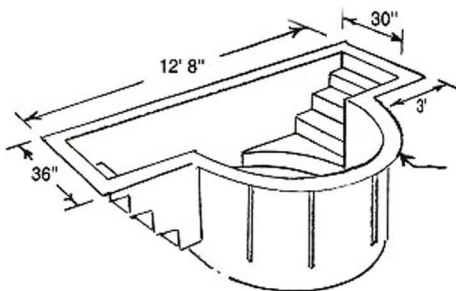

Model 14 (double) - Price \$ 2275.00
 9'8"L x 86"W x 43"D - 800 gals. - 500 lbs.
 No window available

Model not shown:

Model 14 (single) - Price \$1999.00
 9'8"L x 86"W x 43"D - 750 gals. - 500 lbs.
 No window available

Models 7A & 14 have various step configurations

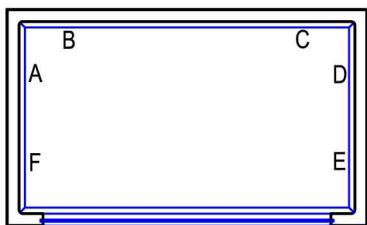

Top view of Model 7A

Common Step Locations:

- A Left Rear Side Entry
- B Left Rear Back Entry
- C Right Rear Back Entry
- D Right Rear Side Entry
- E Right Front Side Entry
- F Left Front Side Entry

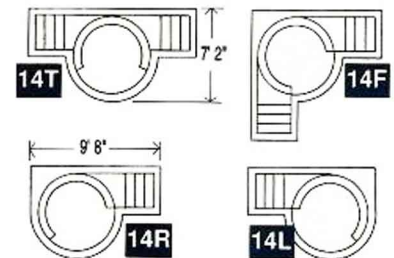

Top view of Model 14

Baptistry Accessories

FITTINGS & FIXTURES

#172 Trip Lever Drain Overflow & Release

3 Ft. or 3 ½ Ft. Trip Lever Unit. Can be installed at any location. Simply operate lever at overflow to open and close drain valve. "O" Rings on valve prevent leakage.

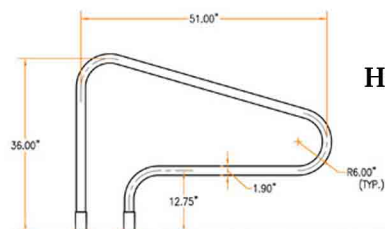
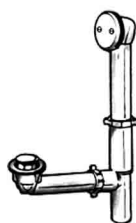

Hand Rails

#700 Single Fill Faucet ½" S.P.S



Make it easier safer for your celebrants to enter and exit the baptistry with a stainless steel handrail system. Mounts directly to the landing floor, and may be easily installed on concrete, tile, wood & metal.

#6895 Electrical Interrupter is designed to turn off all power to the Baptistry Heating Electrical System if there is a short of only 5 to 6 mili amps. Protecting people from electrical shock. The National Electrical Codes in many states, counties and cities are requiring that a ground fault interrupter must be installed in electrical systems where it is possible for people to be subjected to a short-to-ground condition. The #230, rated at 30A will handle the 6KW, or 11.5KW Circulation Heaters. Wiring diagrams are supplied with the Ground Fault Interrupter. Always install GFI as close to the heater as possible. Nipple the GFI to the contactor box or heater cover box.



Immersion Baptistry Water Heater

The 240V heater will heat 60 Gallons per hour to a 40 degree rise. A 750 - 1000 gallon tank will heat in 13 - 17 hours. If you select the 120V model, the heater will operate at 120 volts and power will be reduced to 1.5 KW and will heat 15 GPH to 40 degree rise.

Deluxe Baptistry Heater



The ChurchRite 240 V Circulation Heater features an stainless steel housing (no rust), a 1/2 HP pump motor, and thermostat control. Available in 5.5 KW and 11 KW sizes. The 5.5 will heat the average 500 gallon baptistry in 6 hours by 30 degrees F. The 11 KW will heat the same baptistry by 36 degrees F in about 4 hours. Can be installed up to 12 feet from baptistry. Heating indicator light. Adjustable thermostat. GFCI included. Air button On/Off switch. Receptacle for the optional Auto/Fill Drain Unit. Easy assembly required.

One Year Ltd. Manufacturer's Warranty

6KW Circulation Baptistry Heater

Incoloy Steel Heating Elements / Adjustable Thermostat
Well Insulated with Fiberglas / 240v single phase power
Can be used with 208v, but heating is reduced 25%
Can be used with 120v, but heating is reduced 75%
pump is 1/40 H.P. - 120v - circulated 600 GPH at 1' head
Hi-limit switch is set at 118°F (± 4°)
Kits include heater, pump, installation kit
FREE DELIVERY TO 48 STATES



Filter/Skimmer

We also offer a cartridge style skimmer/filter for use with your baptistry to help keep bugs out and keep your baptistry clean for use at any time.

Contact us today
www.ChurchPools.com
800-639-7397

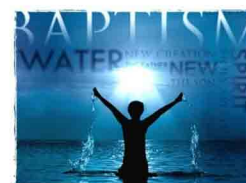

Check Website for up to date pricing